



TOW SOLUTIONS

GETTING THE JOB DONE

SAFELY



At ECCO, we appreciate just how dangerous the towing industry can be. Tow truck operators work all hours of the day and night in all kinds of weather. Your "office" is usually the side of a busy highway—a potentially life threatening place to be. Aside from the threat of inattentive drivers, the task of loading disabled vehicles onto wreckers poses its own risks. And those loaded vehicles limit rear visibility which can increase the likelihood of a collision.

ECCO offers an extensive line of safety solutions that are ideally suited to tow vehicles. Our high-intensity LED warning lights notify approaching drivers of a hazard, while our range of worklamps ensures that you can see clearly, even in the lowest visibility situations. ECCO's reversing safety solutions include back-up alarms to warn other drivers and pedestrians when you're reversing and camera systems to help you avoid obstacles. We make it our job to offer warning equipment to help minimize the risk of personal injury and property damage.



**Read on to learn about
specially selected products for
tow trucks, large and small.**



LIGHTBARS

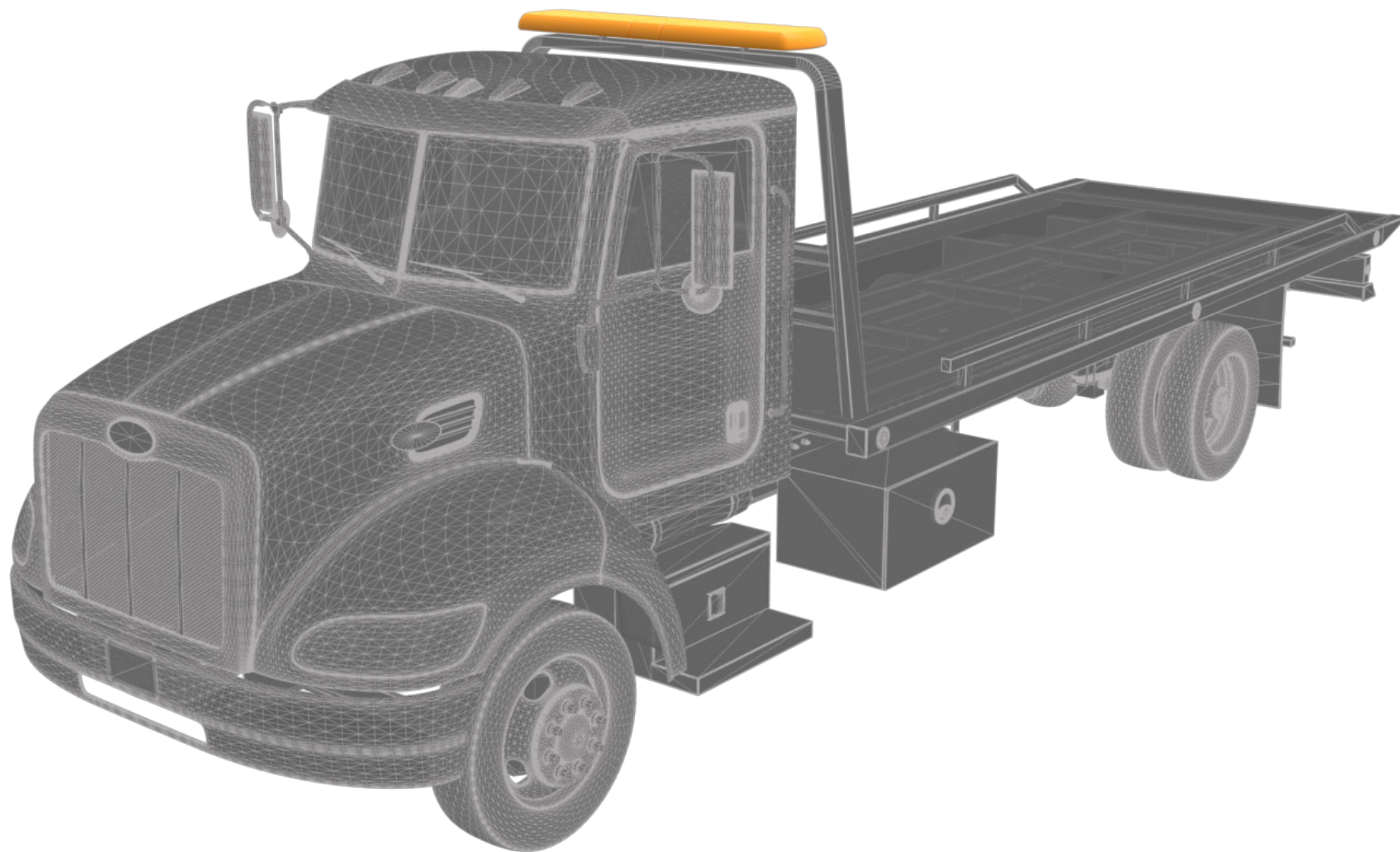

Recommended installation location

TOW SOLUTIONS

12 Series VANTAGE

SAE Class I LED Lightbar



- 54"** # 12-00005-E
C Amber
T 16 LEDs, 2 WL, 2 AL, 2 STT
V 12-24
A 11.0
 SAE J845 Class I, California Title 13, CE, R10
 3 Year



- 60"** # 12-00006-E
C Amber
T 16 LEDs, 2 WL, 2 AL, 2 STT
V 12-24
A 11.0
 SAE J845 Class I, California Title 13, CE, R10
 3 Year



- 54"** # 12-00007-E
C Amber
T 10 LEDs, 2 WL, 2 STT
V 12-24
A 6.5
 SAE J845 Class I, California Title 13, CE, R10
 3 Year

14 Series AXIOS

SAE Class I Modular LED Lightbar



- 54"** # 14-00002-E
C Amber
T 12 LEDs, 2 WL, 2 AL, 2 STI, 1 Safety Director
V 12-24
A 17.5
 SAE J845 Class I, Cal. Title 13, R65, R10, R6 & R7
 5 Year



- 60"** # 14-00003-E
C Amber
T 14 LEDs, 2 WL, 2 AL, 2 STI
V 12-24
A 16.8
 SAE J845 Class I, Cal. Title 13, R65, R10, R6 & R7
 5 Year



- 54"** # 14-00007-E
C Amber
T 10 LEDs, 2 WL, 2 STI
V 12-24
A 11.4
 SAE J845 Class I, Cal. Title 13, R65, R10, R6 & R7
 5 Year

21 Series

SAE Class I LED Lightbar



- 52"** # 21-00007-E
C Amber
T 10 LEDs, 2 STI, 2 WL
V 12
A 8.0
 SAE J845 Class I, Cal. Title 13
 5 Year



- 58"** # 21-00008-E
C Amber
T 12 LEDs, 2 STI, 2 WL
V 12
A 9.0
 SAE J845 Class I, Cal. Title 13
 5 Year



- 58"** # 27-00007-E
C Amber
T 10 LEDs, 2 STI, 2 WL
V 12
A 8.0
 SAE J845 Class I, Cal. Title 13
 5 Year

AVAILABLE COLORS (12, 14, & 21 Series)
 Amber, Blue, Green, Red & White

 Custom configurations available

AVAILABLE COLORS (27 Series)
 Amber, Blue, Red & White

 Custom configurations available

360° WARNING

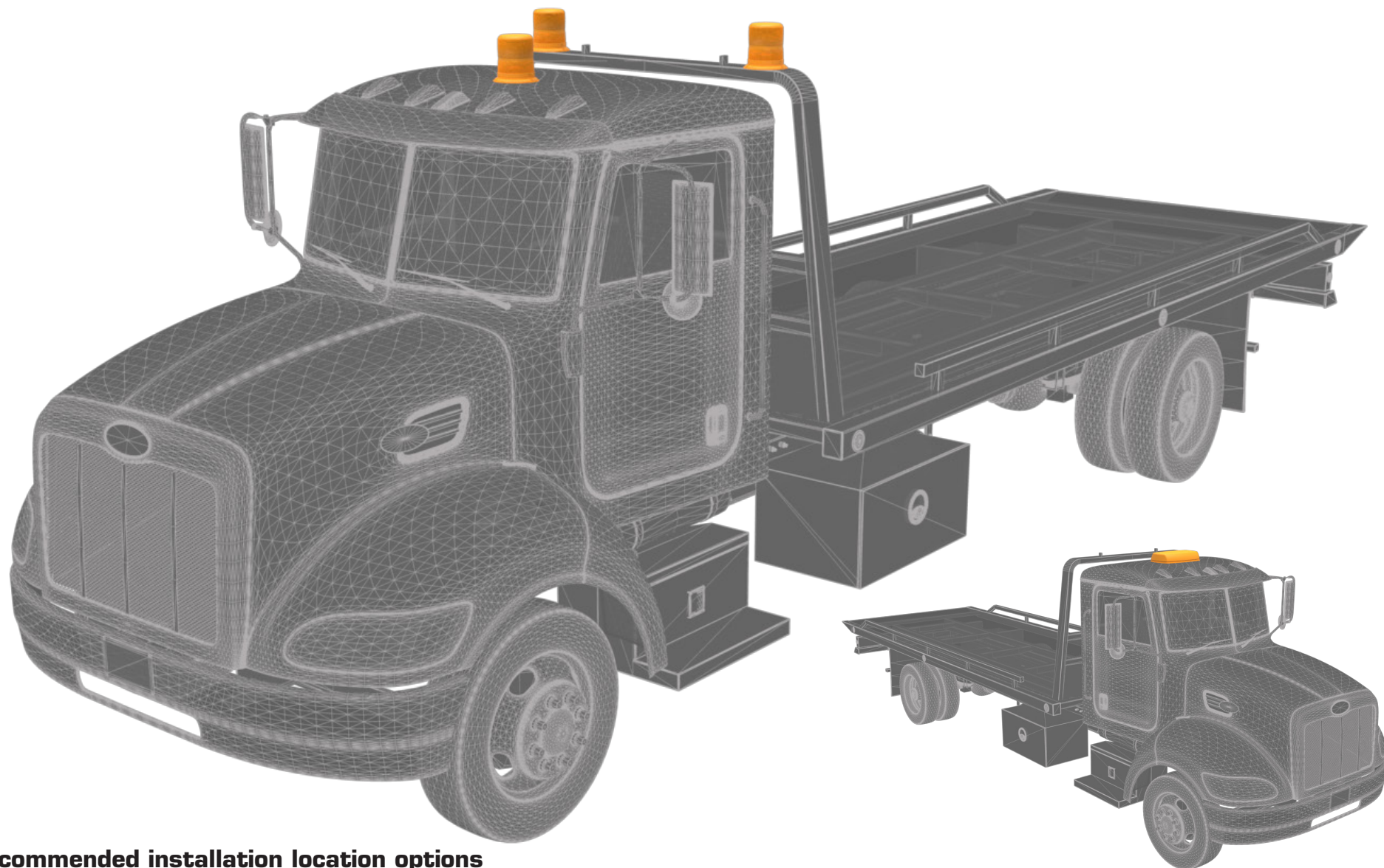

Recommended installation location options

TOW SOLUTIONS

Minibars

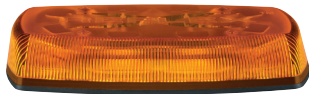

- # 5585A REFLEX**
C Amber
V 12-24
A 5.1
X 4 Bolt
⊕ SAE J845 Class I, CE, R10, IP65
⌚ 3 Year

AVAILABLE COLORS

Amber, Blue, Clear, Green, Red & Amber/Clear (MG models amber illumination only)



- # 5587A REFLEX**
C Amber
V 12-24
A 5.1
X 4 Bolt
⊕ SAE J845 Class I, CE, R10, IP65
⌚ 3 Year

AVAILABLE COLORS

Amber, Clear, Amber/Clear (MG models amber & amber/clear only)



- # 5590A REFLEX**
C Amber
V 12-24
A 6.0
X 4 Bolt
⊕ SAE J845 Class I
 California Title 13, CE, R10, IP65
⌚ 3 Year

AVAILABLE COLORS

Amber, Blue, Clear, Green & Red (MG models amber & amber/clear only)



- # 5597A REFLEX**
C Amber
V 12-24
A 6.0
X 4 Bolt
⊕ SAE J845 Class I, California Title 13, CE, R10, IP65
⌚ 3 Year

AVAILABLE COLORS

Amber, Clear, Amber/Clear (MG models amber & amber/clear only)



Beacons



- # 7965A**
C Amber
V 12-24
A 3.6
X 3 Bolt / 1" Pipe
⊕ SAE J845 Class I, CE, R10
⌚ 2 Year

AVAILABLE COLORS (7900 SERIES)

Amber, Blue, Clear, Green & Red



CA models = clear lens / amber illumination | CC models = clear lens / clear illumination



- # 7970A**
C Amber
V 12-24
A 3.6
X 3 Bolt / 1" Pipe
⊕ SAE J845 Class I, CE, R10
⌚ 2 Year



- # EB7180A**
C Amber
V 12-24
A 6.2
X 3 Bolt / 1" Pipe
⊕ SAE J845 Class I, Cal. Title 13, R10, IP55, AMECA
⌚ 3 Year

AVAILABLE COLORS (EB7180 / EB7185)

Amber, Clear/Amber/Amber, Clear/Amber/Clear & Clear/Clear/Clear



CAA models = clear lens / amber illumination | CAC models = clear lens / amber and clear illumination | CCC models = clear lens / clear illumination



- # EB7180A-VM**
C Amber
V 12-24
A 6.2
X Vacuum-Magnet
⊕ SAE J845 Class I, Cal. Title 13, R10, IP55, AMECA
⌚ 3 Year



- # EB7185A Dual-color**
C Amber
V 12-24
A 8.6
X 3 Bolt / 1" Pipe
⊕ SAE J845 Class I, Cal. Title 13, R10, IP55, AMECA
⌚ 3 Year



- # EB7185A-VM Dual-color**
C Amber
V 12-24
A 8.6
X Vacuum-Magnet
⊕ SAE J845 Class I, Cal. Title 13, R10, IP55, AMECA
⌚ 3 Year

DIRECTIONAL LEDs

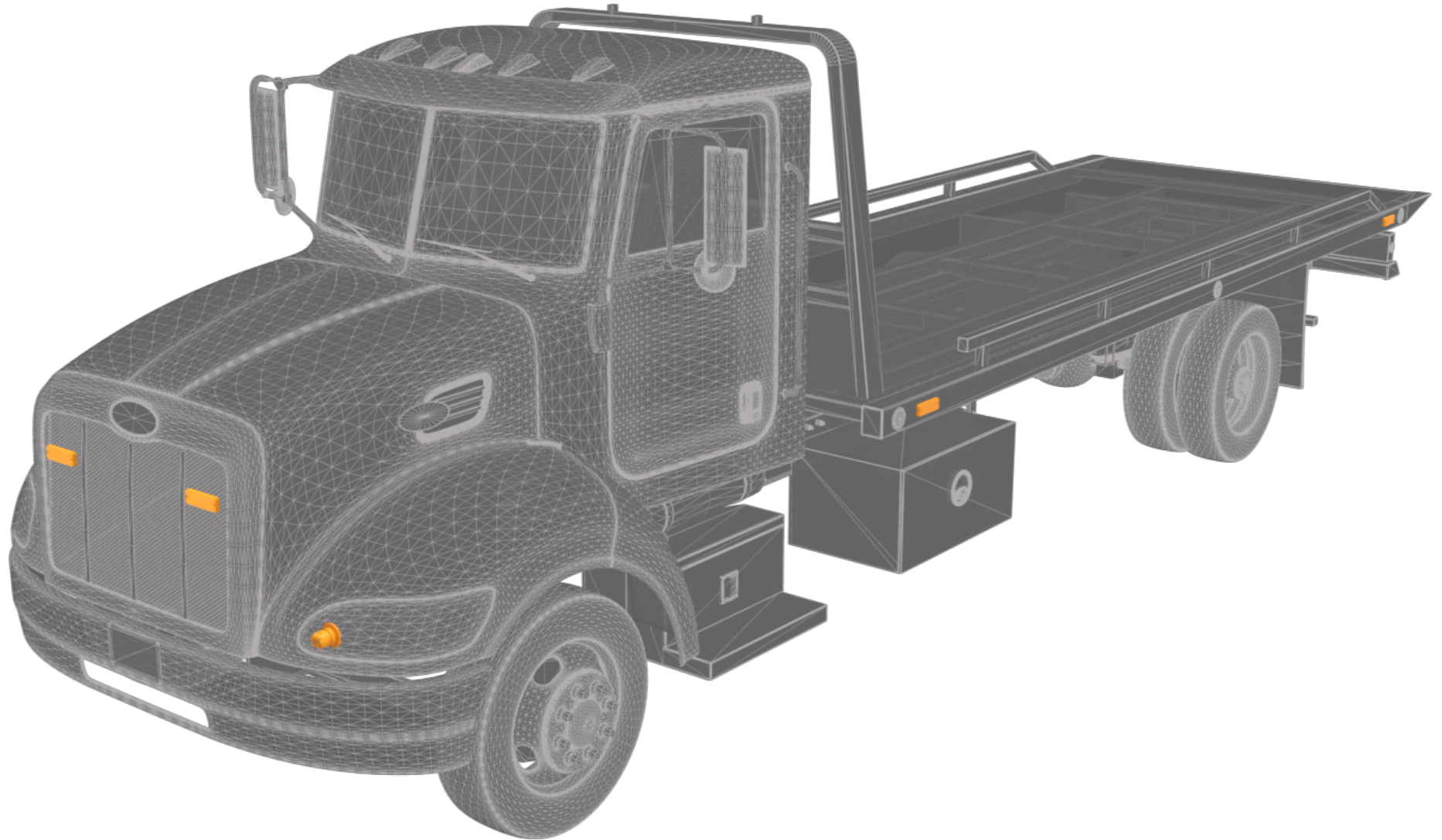

Recommended installation location options

TOW SOLUTIONS



- # ED3701A** Solid- or split-color
C Amber
V 12-24
A 0.8
X 2 Bolt
 SAE J595 Class I
 California Title 13, R65, R10
 3 Year

AVAILABLE COLORS

Amber, Blue, Clear, Green, Red, Amber/Blue, Amber/Clear, Amber/Green, Amber/Red, Blue/Clear, Red/Blue & Red/Clear



- # ED3706A** Solid- or split-color
C Amber
V 12-24
A 0.9
X Multi-Mount (surface, tilt bracket, self-adhesive, edge)
 SAE J595 Class I, California Title 13, R65, R10, IP67
 3 Year

AVAILABLE COLORS

Amber, Blue, Clear, Green, Red, Amber/Blue, Amber/Clear, Amber/Green, Amber/Red, Red/Blue



- # 3510A**
C Amber
V 12-24
A 0.75
X 2 Bolt
 SAE J595 Class I
 California Title 13, CE, R10
 5 Year

AVAILABLE COLORS

Amber, Blue, Clear, Green & Red



- # ED3702AC** Dual-color
C Amber/Clear
V 12-24
A 0.6
X 2 Bolt
 SAE J595 Class I
 California Title 13, R65, R10
 3 Year

AVAILABLE COLORS

Amber/Blue, Amber/Clear, Amber/Green, Amber/Red, Blue/Clear, Red/Blue & Red/Clear



- # ED3712AC** Dual-color
C Amber/Clear
V 12-24
A 0.9
X Multi-Mount (surface, tilt bracket, self-adhesive, edge)
 SAE J595 Class I, California Title 13, R65, R10
 3 Year

AVAILABLE COLORS

Amber/Blue, Amber/Clear, Amber/Green, Amber/Red, Blue/Clear, Red/Blue & Red/Clear



- # 9014A** Hide-A-LED
C Amber
T 6 LEDs
 1 Head
V 12-24
A 0.9
X 2 Bolt
 CE, R10, IP67
 2 Year

AVAILABLE COLORS

Amber, Blue, Clear & Red



- # 3703A / 3704A / 3705A**
C Amber
V 12-24
A 0.5
X 2 Bolt
 SAE J595 Class I, R10
 3 Year

AVAILABLE COLORS

Amber, Blue, Clear, Green & Red



Synchronization Capable

Where applicable, change A in part number to available color

WHITE LIGHTING

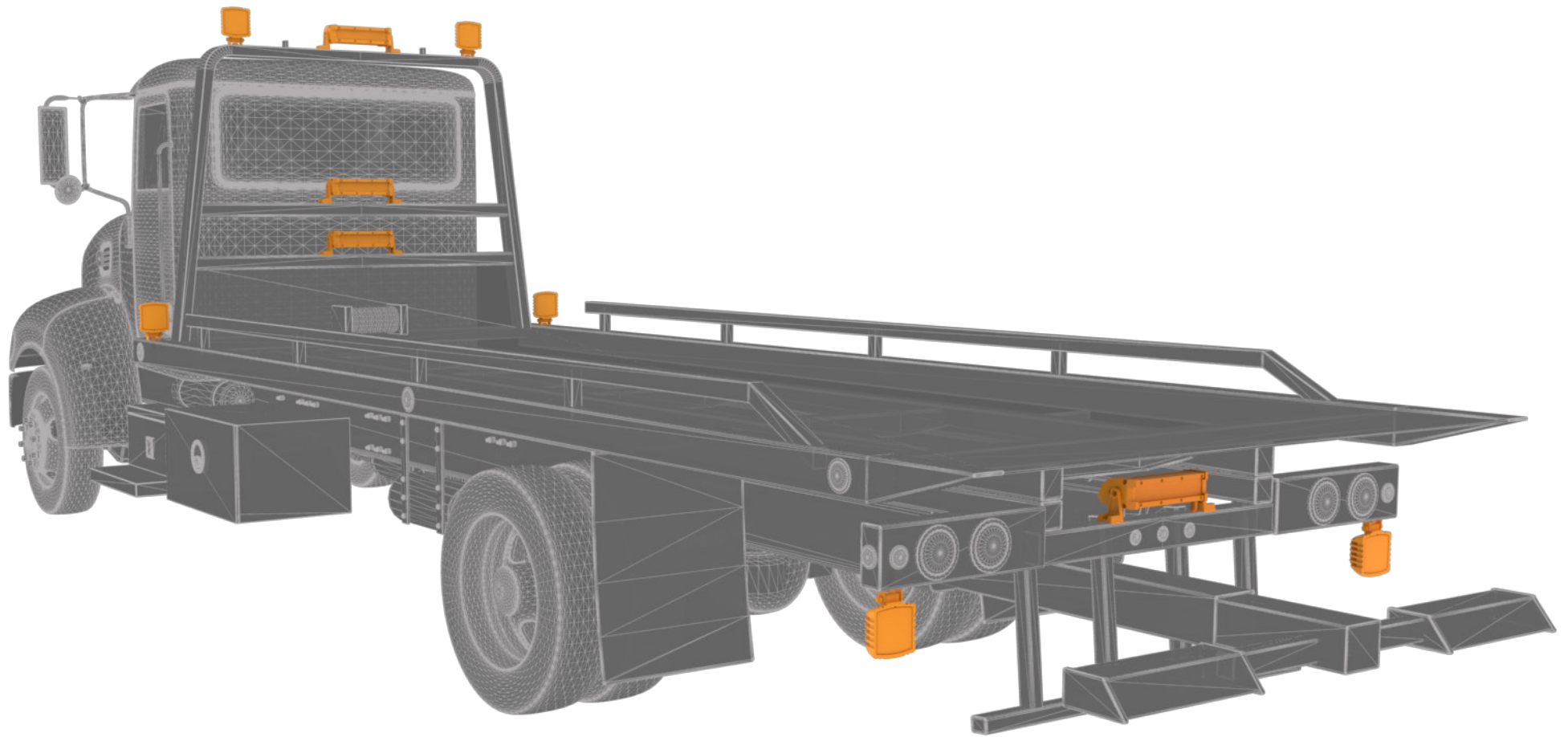

Recommended installation location options

TOW SOLUTIONS

Worklamps



- # E92006
- V 12-24
- A 1.3
- L 1300 Raw, 1200 Effective
- Flood
- CE
- 2 Year



- # E92013
- V 12-24
- A 0.9
- L 650 Raw, 600 Effective
- Flood
- CE
- 1 Year



- # EW2411
- V 12-24
- A 1.3
- L 1000 Raw, 900 Effective
- Flood
- IP67, CE, R10
- 3 Year



- # EW2450
- V 12-24
- A 2.2
- L 1300 Raw, 1100 Effective
- Spot
- CE
- 3 Year



- # EW2451
- V 12-24
- A 2.2
- L 1300 Raw, 1100 Effective
- Flood
- CE
- 3 Year



- # EW2102 
- V 12-24
- A 2.6
- L 2000 Raw, 1600 Effective
- Flood
- CE, R10, IP67
- 3 Year



- # EW2461CA-NA
- V Clear / Amber
- A 12-24
- L 650 Raw, 600 Effective (clear)
- Flood
- 1 Year

Utility Bars



- # EW3108-F
- T 8" Single Row
- V 12-24
- A 1.9
- L 1100 Raw, 1000 Effective
- Flood
- IP67, R10
- 3 Year



- # EW3208-F
- T 8" Double Row
- V 12-24
- A 3.8
- L 2150 Raw, 1950 Effective
- Flood
- IP67, R10
- 3 Year



- # EW3114
- T 14" Single Row
- V 12-24
- A 5.7
- L 3350 Raw, 2600 Effective
- Flood / Spot Combo
- IP67, R10
- 3 Year



- # EW3214
- T 14" Double Row
- V 12-24
- A 9.3
- L 6700 Raw, 4800 Effective
- Flood / Spot Combo
- IP67, R10
- 3 Year

Additional utility bar lengths & configurations available

INTERIOR LIGHTING

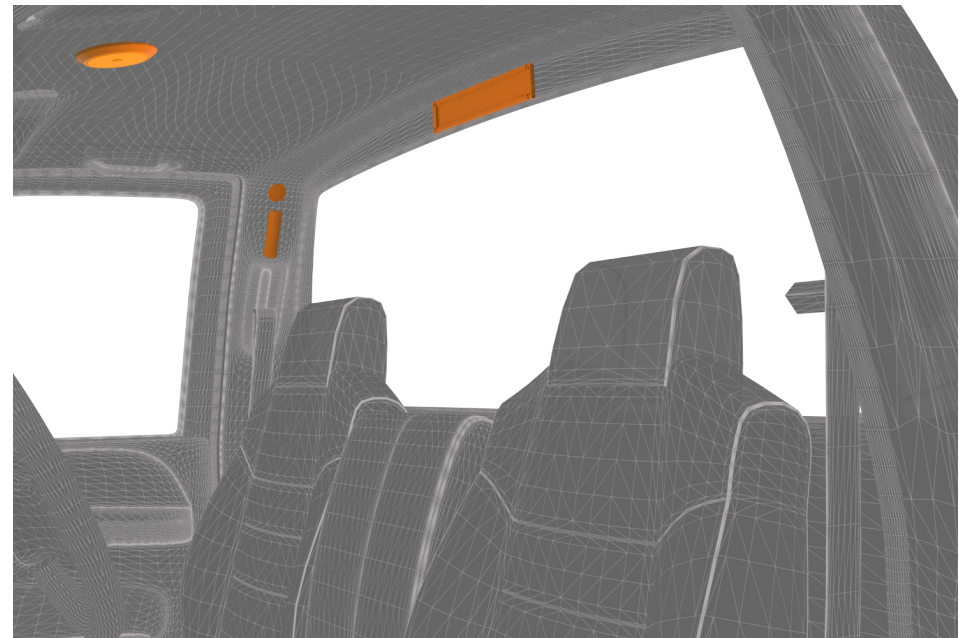
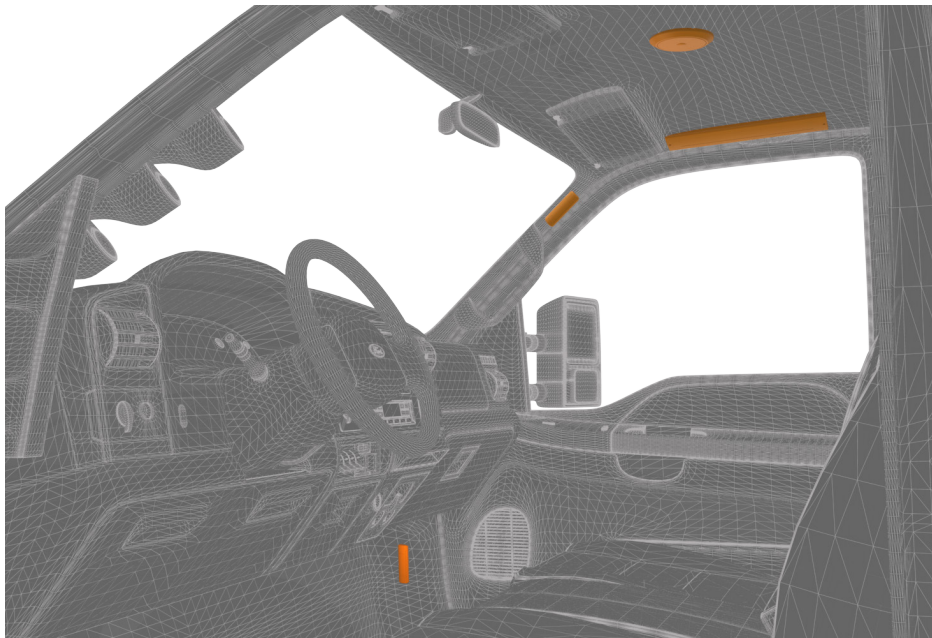



Recommended installation location options



TOW SOLUTIONS

Strip Lighting



- 12"**
EW0116
T 18 LED
V 12
A 0.4
L 350 Raw, 350 Effective
 Flood
 CE, RoHS, IP65
 3 Year



- 24"**
EW0117
T 36 LED
V 12
A 0.7
L 700 Raw, 700 Effective
 Flood
 CE, RoHS, IP65
 3 Year



ACCESSORIES

EZ0120 PIR Motion Sensor - 110° cone, adjustable sensitivity (automatically activates light when human movement is detected)





Interior Lighting





- 5.5"**
EW0400
T 10 LED
V 12-24
A 0.4
L 200 Raw, 200 Effective
 Flood
 CE, R10, RoHS, IP64
 3 Year





- 12"**
EW0401
T 22 LED
V 12-24
A 0.7
L 450 Raw, 450 Effective
 Flood
 CE, R10, RoHS, IP64
 3 Year





- 5.5"**
EW0200
T 72 LED
V 12-24
A 0.4
L 400 Raw, 400 Effective
 Flood *Amplia*
 CE, RoHS
 3 Year





- 7"**
EW0500
T 42 LED
V 12-24
A 0.5
L 250 Raw, 200 Effective
 Flood
 CE, R10, RoHS
 3 Year





- 15"**
EW0503
T 108 LED
V 12-24
A 0.8
L 600 Raw, 550 Effective
 Flood
 CE, R10, RoHS
 3 Year



- 13"**
EW0700
T 6 LED
V 12-24
A 0.5
L 400 Raw, 350 Effective
 Flood
 CE, RoHS
 3 Year



- 22"**
EW0701
T 12 LED
V 12-24
A 0.9
L 1250 Raw, 1200 Effective
 Flood
 CE, RoHS
 3 Year

REVERSING SAFETY

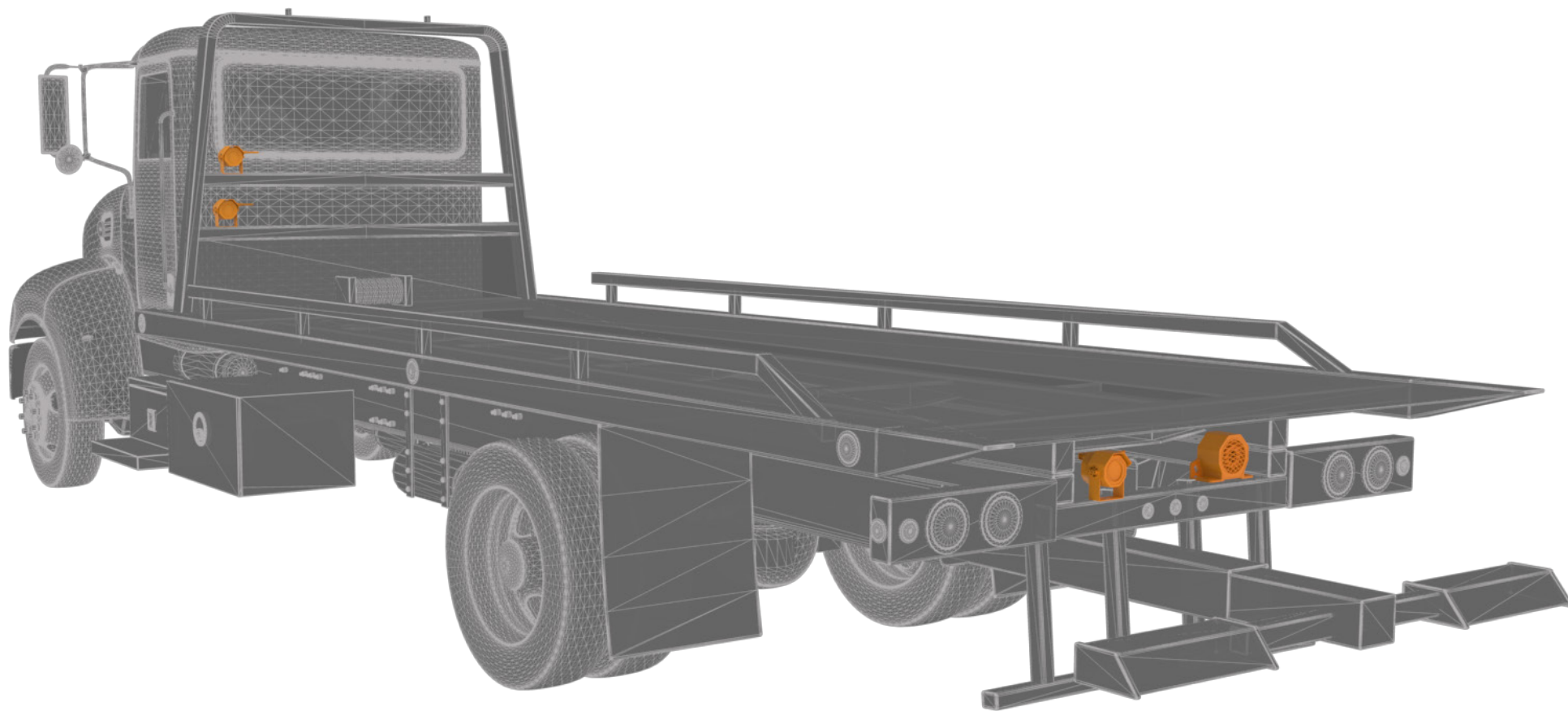

Recommended installation location options

TOW SOLUTIONS

Back-Up Alarms



- # 510
- T SRC*
- V 12
- dB(A) 97
- A 0.2
- X 2 Bolt
- Ⓢ SAE J994 Type C, CE, R10, UL, AMECA, IP65
- 🕒 2 Year

- # 530
- T SRC*
- V 12-24
- dB(A) 102
- A 1.0
- X 2 Bolt
- Ⓢ SAE J994 Type F CE, R10, UL, IP65
- 🕒 2 Year

- # SA950 SMART ALARM
- V 12-24
- dB(A) 82-102
- A 0.4
- X 2 Bolt
- Ⓢ CE, R10, UL, IP65
- 🕒 2 Year



- # 415
- V 12-24
- dB(A) 97
- A 0.2
- X Grommet
- Ⓢ SAE J994 Type C, CE, R10
- 🕒 2 Year

- # SA955 SMART ALARM
- V 12-24
- dB(A) 82-102
- A 0.4
- X Grommet
- Ⓢ CE, R10
- 🕒 2 Year

Multi-Frequency Alarm



- # EA5200 MULTI FREQUENCY
- V 12-24
- dB(A) 97
- A 1.0
- X 2 Bolt
- Ⓢ SAE J994 Type C CE, R10, AMECA
- 🕒 2 Year

Camera Systems



EC5603-K *Gemincye*
 5.6" LCD color system
 Touchscreen menu control
 CMOS 11 LED infrared camera
 Includes monitor sunshade
 Three camera expandable
 One year warranty



EC5605-WK *Gemincye*
 5.6" LCD color system
 2.4 GHz digital wireless system
 Touchscreen menu control
 CMOS 11 LED infrared camera
 2 Bolt
 Includes monitor sunshade
 Four camera expandable
 One year warranty



K7000B *Gemincye*
 7" LCD color system
 CMOS 18 LED infrared camera
 Includes monitor sunshade
 Two camera expandable
 One year warranty



EC7000-QK *Gemincye*
 7" Quad view LCD color system
 Quad view, split screen
 CMOS 11 LED infrared camera
 Four camera expandable
 One year warranty



EC7003-K *Gemincye*
 7" LCD color system
 Touchscreen menu control
 CMOS 11 LED infrared camera
 Includes monitor sunshade
 Three camera expandable
 One year warranty



Worldwide leader in
commercial and emergency
vehicle warning and safety products

www.eccosafetygroup.com



833 West Diamond Street, Boise, Idaho 83705
(800) 635-5900 | sales@eccolink.com | www.eccolink.com

A Division of ESG | www.eccosafetygroup.com



© 2016 Electronic Controls Company
TOWBROCHURE (1016 - Digital)